



**FICHE D'HOMOLOGATION  
HOMOLOGATION FORM**

**COMMISSION INTERNATIONALE  
DE KARTING - FIA**



## SYSTÈME DE FREINAGE / BRAKING SYSTEM

Constructeur	<i>Manufacturer</i>	Hetschel GmbH & Co. KG
Marque	<i>Make</i>	HRP
Modèle	<i>Model</i>	VH X
Catégorie	<i>Category</i>	Toutes / All
Durée de l'homologation	<i>Validity of the homologation</i>	6 ans / years
Nombre de pages	<i>Number of pages</i>	4

La présente Fiche d'Homologation reproduit descriptions, illustrations et dimensions du système de freinage au moment de l'homologation CIK-FIA. Le Constructeur a la possibilité de les modifier, mais seulement dans les limites fixées par le Règlement CIK-FIA en vigueur.

*This Homologation Form reproduces descriptions, illustrations and dimensions of the brake system at the moment of the CIK-FIA homologation. The Manufacturer may modify them, but only within the limits set by the CIK-FIA Regulations in force.*

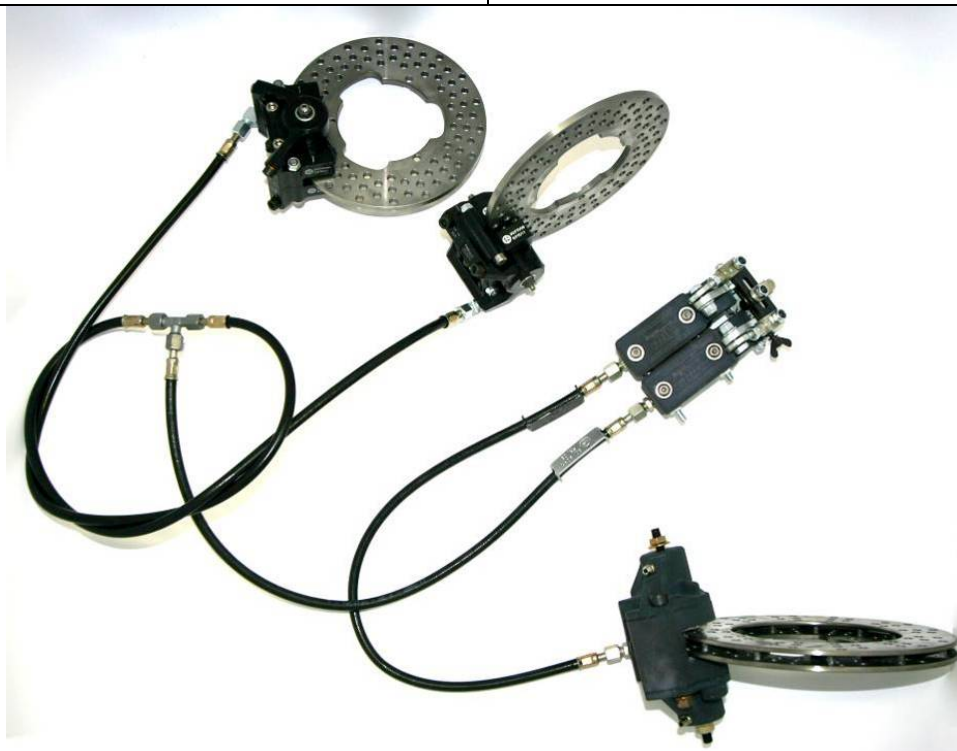



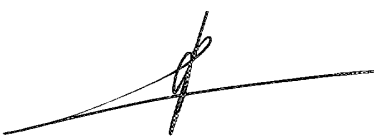
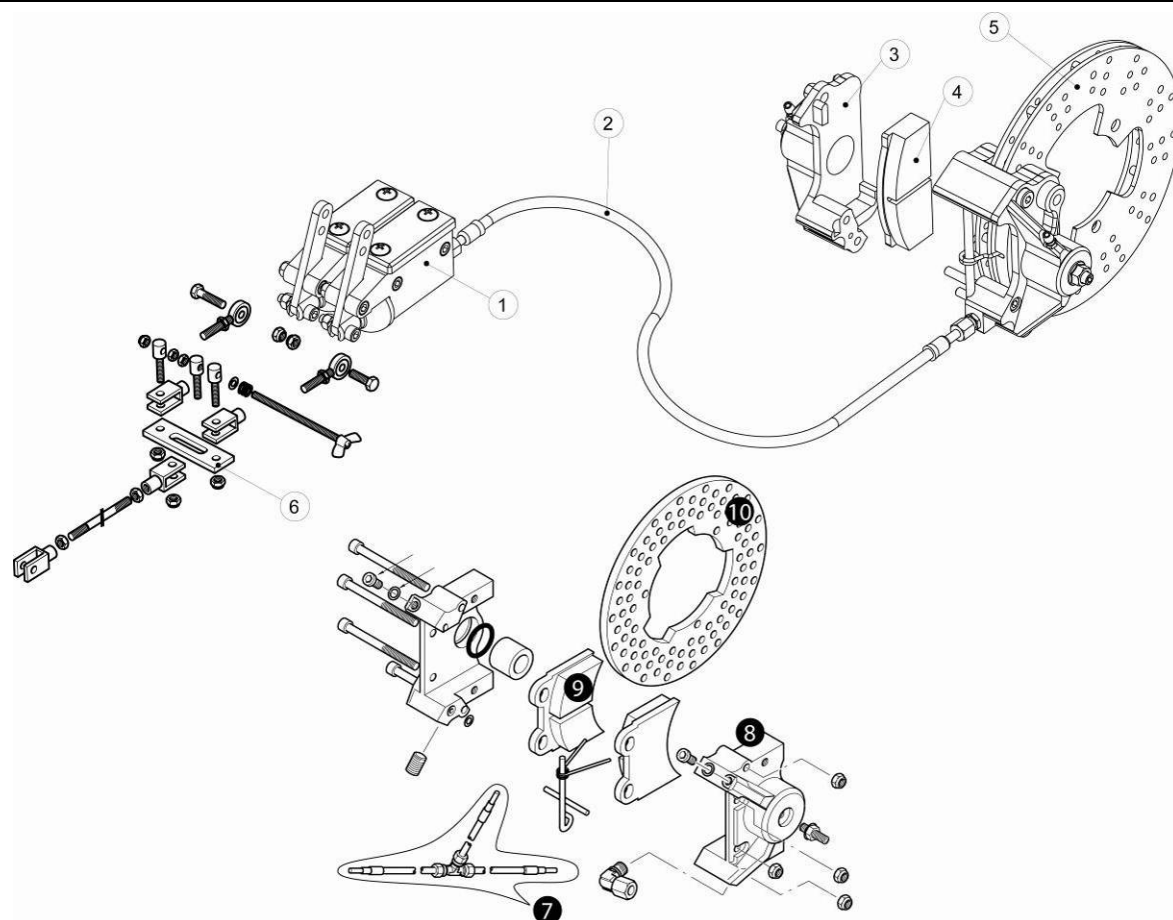

PHOTO VUE DE DESSUS DU SYSTÈME COMPLET ASSEMBLÉ  
PHOTO FROM ABOVE OF COMPLETE ASSEMBLED SYSTEM

Signature et tampon de l'ASN <i>Signature and stamp of the ASN</i>	Signature et tampon de la CIK-FIA <i>Signature and stamp of the CIK-FIA</i>
 	 

A	<b>DESSIN TECHNIQUE DU SYTÈME DE FREINAGE</b> Dessin technique éclaté	A	<b>TECHNICAL DRAWING OF BRAKING SYSTEM</b> Exploded technical drawing
---	--	---	--



**Le dessin technique doit montrer : Maître-cylindre, régulateur, tuyaux, étriers, plaquettes et disques (numérotation selon table ci-dessous)**

**The technical drawing must show the following: Master-cylinder, regulator, lines, calipers, pads and discs (with numbering according table below)**

N°	DÉSIGNATION (en français)	DESIGNATION (in english)	Référence catalogue
			Catalogue reference number
1	maître-cylindre arrière	rear master-cylinder	1227
2	tuyaux	line	1223
3	etrier arrière	rear calliper	1144
4	plaquette arrière	rear pad	1120
5	disque arrière	rear disc	1512
6	reglage mechainique	mechanical adjuster	1300
7	tuyaux	line	1234
8	etrier avant	front calliper	2213/2214
9	plaquette avant	front pad	2301
10	disque avant	front disc	2203

B	DESCRIPTION TECHNIQUE DU SYTÈME DE FREINAGE	B	TECHNICAL DESCRIPTION OF BRAKING SYSTEM	
	Régulateur de freinage <i>Braking regulator</i>	<input checked="" type="checkbox"/> oui / yes <input type="checkbox"/> non / no	Emplacement <i>Location</i>	<u>master brake cylinder</u>
	<b>Avant / Front</b>		<b>Arrière / Rear</b>	
Nombre de maîtres-cylindres <i>Number of master cylinders</i>	<u>1</u>		<u>1</u>	
Alésage Ø <i>Bore Ø</i>	<u>20.6</u> mm		<u>20.6</u> mm	
Nombre de pistons <i>Number of pistons</i>	<u>2</u>	Par étrier <i>Per caliper</i>	<u>2</u>	Par étrier <i>Per caliper</i>
Alésage Ø de l'étrier <i>Caliper bore Ø</i>	<u>25.0</u> mm		<u>28.5</u> mm	
Nombre de plaquettes <i>Number of pads</i>	<u>2</u>	Par étrier <i>Per caliper</i>	<u>2</u>	Par étrier <i>Per caliper</i>
Nombre d'étriers <i>Number of calipers</i>	<u>1</u>	Par roue <i>Per wheel</i>	<u>1</u>	
Matériau des étriers <i>Caliper material</i>	<u>ALU</u>		<u>ALU</u>	
Disques ventilés <i>Ventilated discs</i>		<input type="checkbox"/> oui / yes <input checked="" type="checkbox"/> non / no		<input checked="" type="checkbox"/> oui / yes <input type="checkbox"/> non / no
Épaisseur du disque neuf <i>Thickness of new disc</i>	<u>6</u> mm	+/- 1 mm	<u>14</u> mm	+/- 1 mm
Ø extérieur du disque <i>External Ø of the disc</i>	<u>168</u> mm	+/- 1.5 mm	<u>198</u> mm	+/- 1.5 mm
Ø extérieur de frottement des plaquettes <i>External Ø of pads rubbing surface</i>	<u>168</u> mm	+/- 1.5 mm	<u>197</u> mm	+/- 1.5 mm
Ø intérieur de frottement des plaquettes <i>Internal Ø of pads rubbing surface</i>	<u>107</u> mm	+/- 1.5 mm	<u>126</u> mm	+/- 1.5 mm
Longueur hors-tout des plaquettes <i>Overall length of the pads</i>	<u>56</u> mm	+/- 1.5 mm	<u>95</u> mm	+/- 1.5 mm

**Photo du frein avant : étriers et disques seulement**  
**Photo of front brake: calipers and discs only**

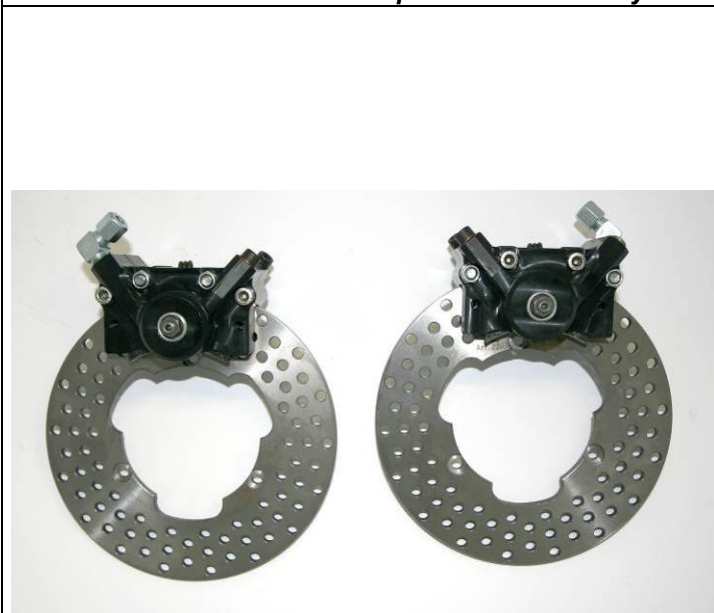

**Photo du frein arrière : étrier(s) et disque(s) seulement**  
**Photo of rear brake: caliper(s) and disc(s) only**



PHOTO DU MARQUAGE DU NUMERO D'HOMOLOGATION  
 PHOTO OF THE HOMOLOGATION NUMBER MARKING

**Le marquage doit rester clairement visible en permanence**  
**The marking must be clearly visible at all times**

Maître-cylindre / Master-cylinder

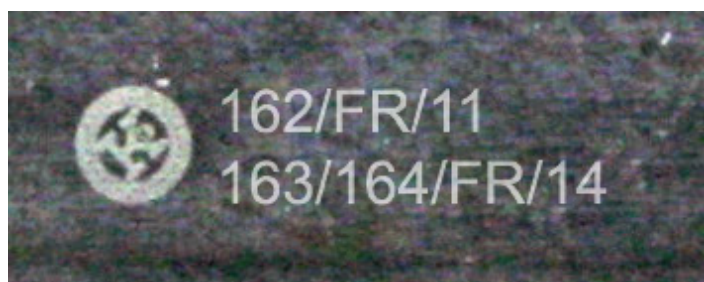

Tuyaux / Lines



Etriers / Calipers



Plaquettes / Pads



Disques / Discs



Régulateur / Regulator